

jeu de gabarits de perçage et installation

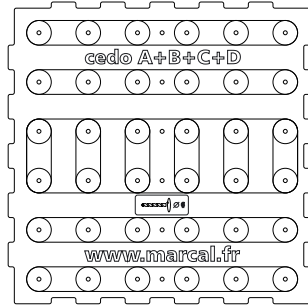

(x2)

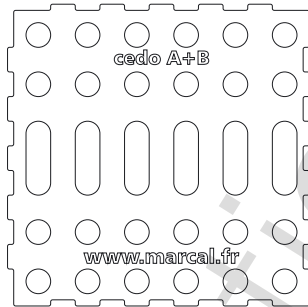

(x2)

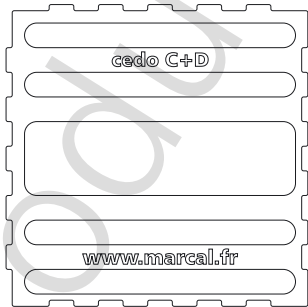

(x2)

gabarit de perçage
et de mise en œuvre
cheminement
podotactile

cedo

cedo A+B+C+D

w 306 x h 306 x d 3 mm
w 12,05 x h 12,05 x d 0,12"

finitions

standards
PVC choc 3mm

mode d'emploi

www.marcal.fr



gabarit de perçage
et de mise en œuvre
cheminement
podotactile

cedo

cedo A+B+C+D

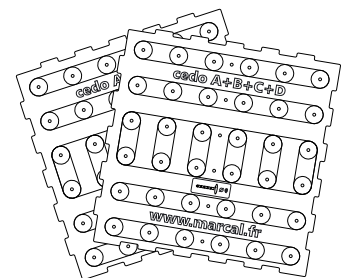
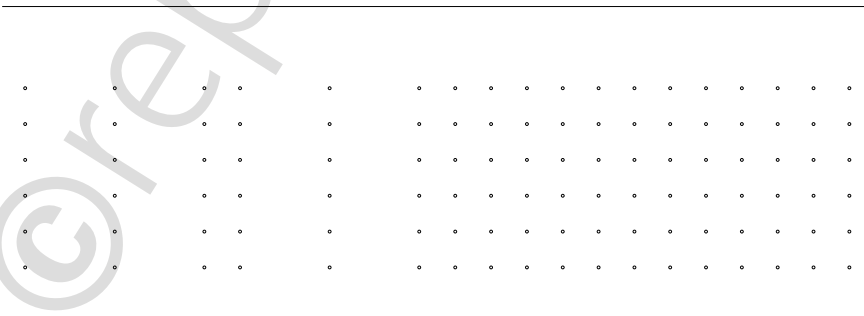
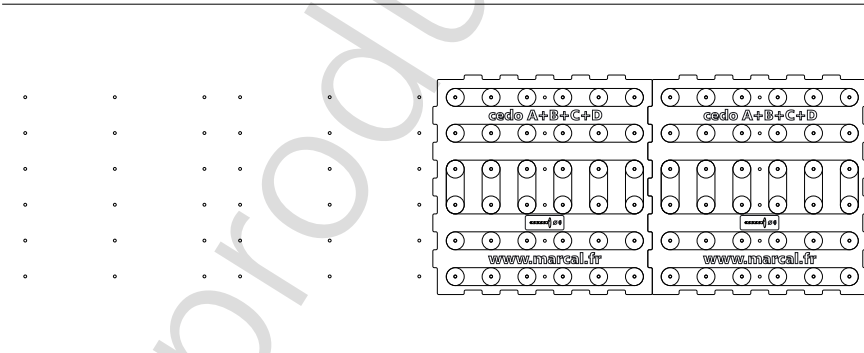
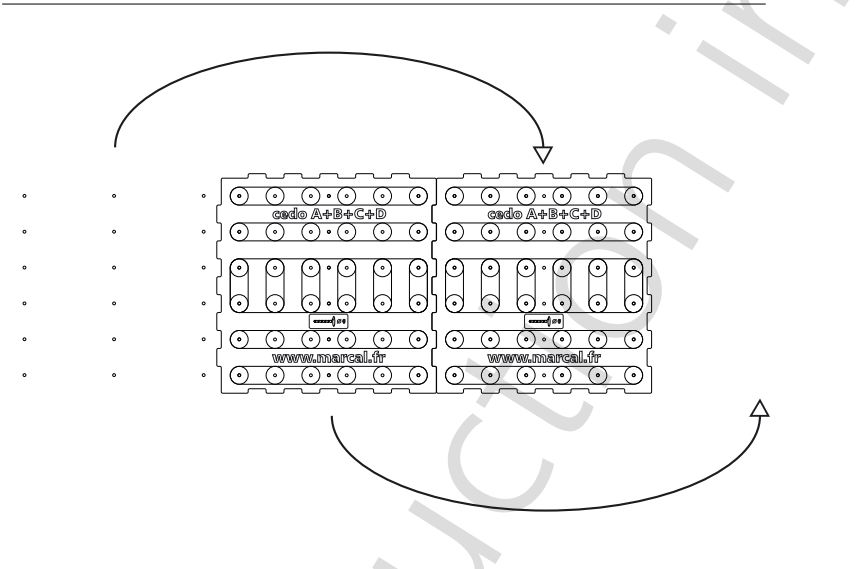
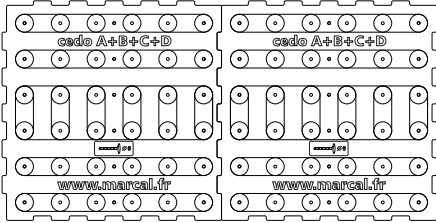

mode d'emploi



gabarit de perçage
et de mise en œuvre
cheminement
podotactile

cedo
cedo A+B+C+D

